

CATÁLOGO

veto®

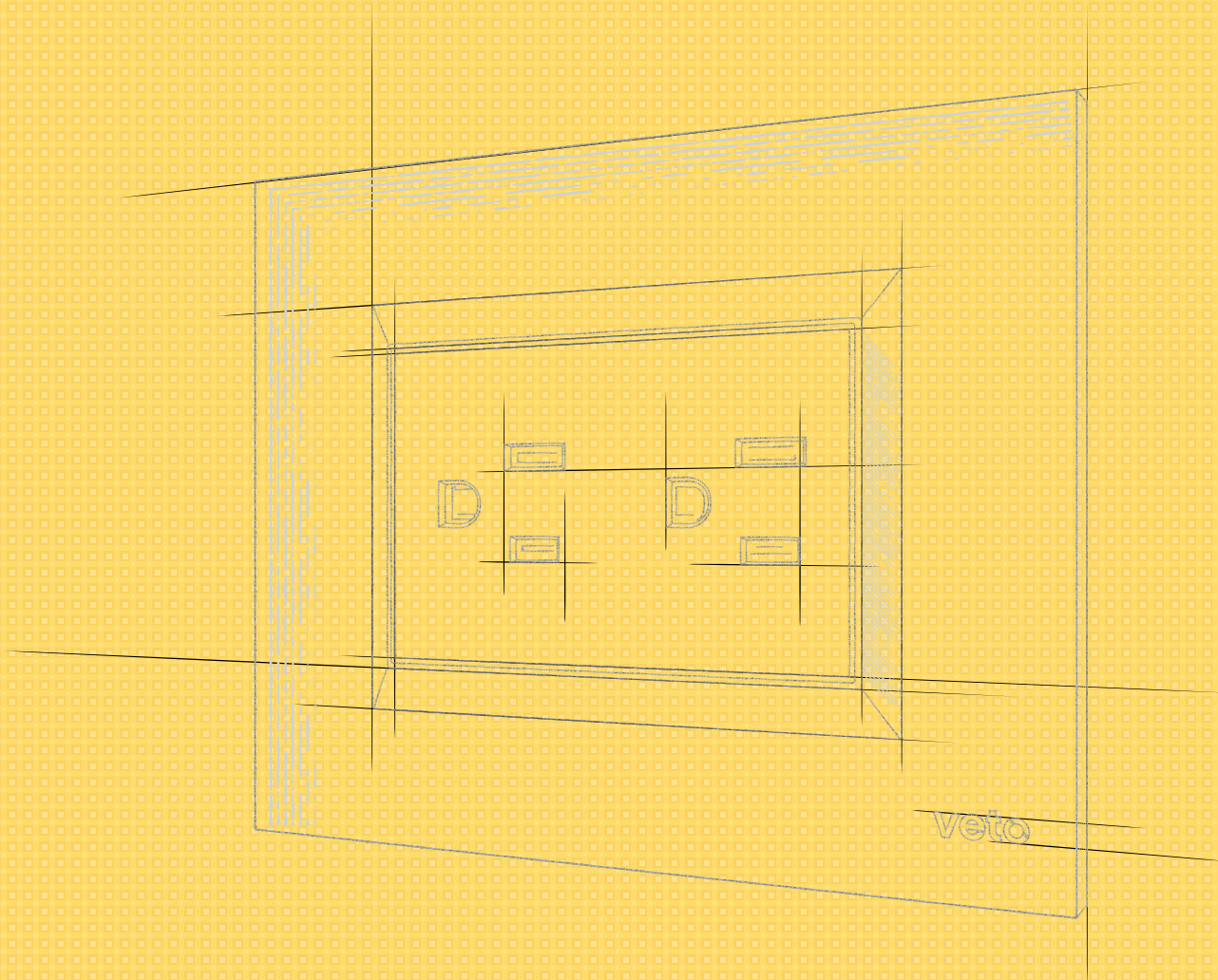

vetc  [®]

veto®

Somos especializados en soluciones de material eléctrico para uso residencial.

Siempre innovando con productos, materiales y procesos productivos con la mejor tecnología



Nacimos en ITALIA en 1937.

Productos con los más altos estándares de calidad que permiten entregar una garantía de 10 años.

Diseño Italiano



ÍNDICE

PLURA



5

PLURA
SMART



21

PREMIUM



25

PREMIUM
SMART



41

PLATA



45

VIVE



59

CLICK



73

ACCESORIOS



77

POWER



81



PLURA_





CARACTERISTICAS

Diseño exclusivo
Sistema modular (Tacos y Placas)
Sistema de luz piloto LED
Interruptores 125/250 Vac 16 Amp
Tomacorrientes 125/250 Vac 15 Amp
Amplia variedad de colores y materiales

CERTIFICACIONES

Certificación que cumple con la Norma
IEC 60669-1 (Interruptores)
IEC 60884-1 (Tomacorrientes)



DIAGRAMA DE INSTALACION

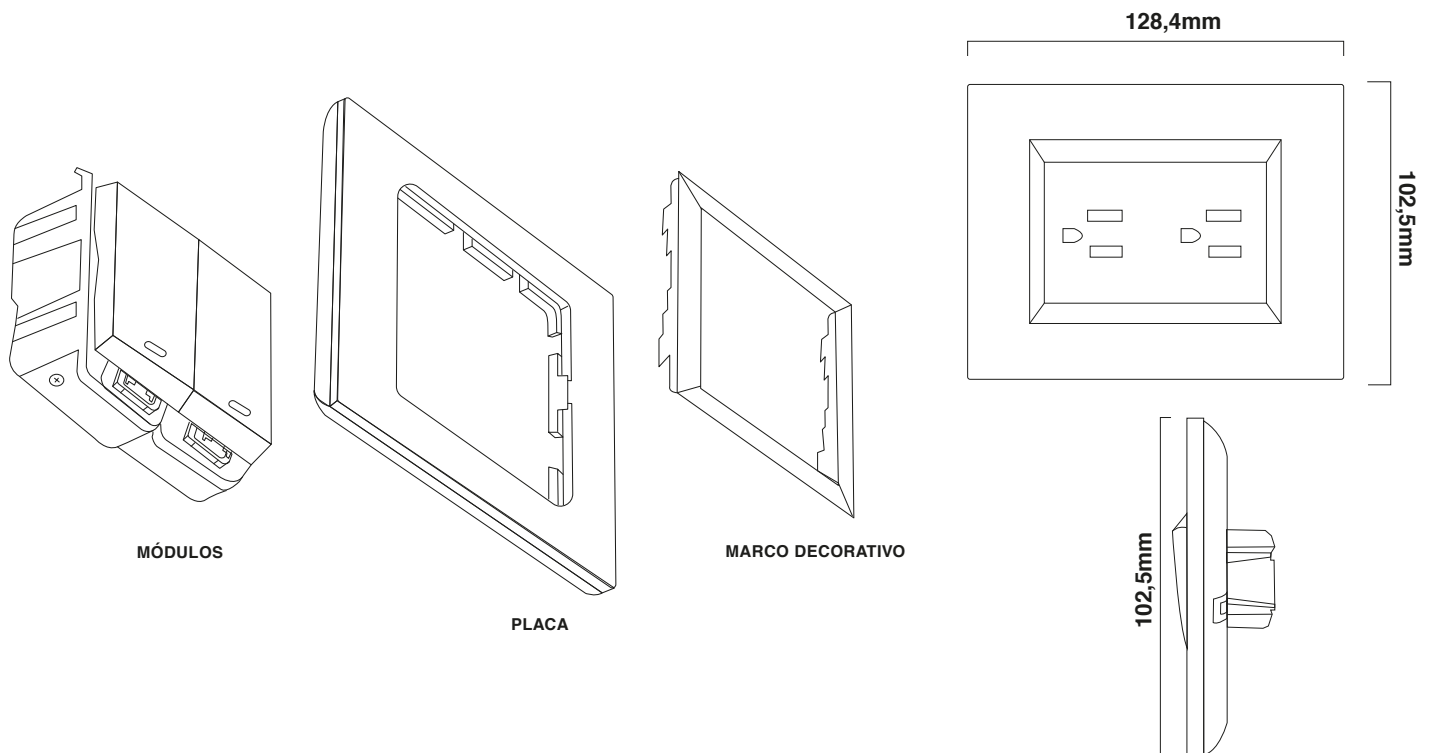

PLURA_



1. Selecciona tu placa favorita
2. Combínala con el marco que más te guste
3. Escoge qué módulos necesitas

PLURA_



MADERA

PLU62082
Placa Madera



TERMOPOLIMERO

PLU60088
Placa
Termopolímero
Blanco



PLU62020
Placa
Termopolímero
Negro



VIDRIO

PLU60019
Placa Vidrio Blanco



PLU60002
Placa Vidrio Negro



METALES

PLU60064
Placa Cobre



PLU60071
Placa Bronce



PLU60057
Placa Acero



PLU60033
Placa Aluminio
Plateada



PLU60040
Placa Aluminio
Negro





MARCOS



MODULOS



MODULOS



PLURA



TOMACORRIENTE AMER 2P+E 36mm



TOMACORRIENTE DOBLE AMER 2P+E 72MM



TOMACORRIENTE UNIV 2P+E 36MM

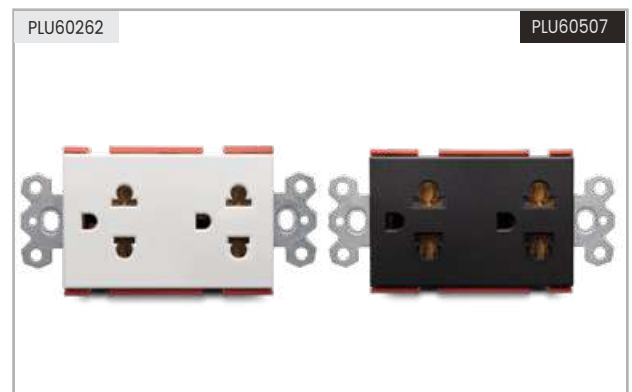

TOMACORRIENTE DOBLE UNIV 2P+E 72MM



TOMACORRIENTE + USB 72MM



DIMMER 36MM 400 W



USB 2.1 AMP 36MM



USB A+C MODULO



COAXIAL 75 OHMS 36MM



JACK TELEFONO RJ25 36MM



JACK DATOS RJ45 CAT 6A 36MM



TAPA CUBRE HUECO 18MM

PLURA



TAPA CUBRE HUECO 24MM



TAPA CUBRE HUECO 36MM

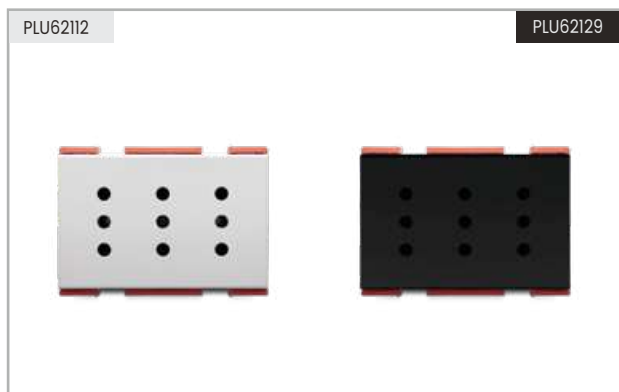

TOMACORRIENTE TRIPLE ITALIANO



PULSADOR TIMBRE 16 AMP 72MM



INT CORTINAS 36MM



PASACABLE FIJADOR



HDMI TIPO A + TAPA CUBRE HUECO 36MM



INTERRUPTOR SIMPLE 16 AMP



INTERRUPTOR DOBLE 16 AMP



INTERRUPTOR TRIPLE 16 AMP



CONMUTADOR SIMPLE 16 AMP



CONMUTADOR DOBLE 16 AMP

PLURA



CONMUTADOR TRIPLE 16 AMP



CONMUTADOR 4 VIAS 16 AMP



INTERRUPTOR + CONMUTADOR 16 AMP



TOMACORRIENTE + INTERRUPTOR



TOMACORRIENTE DOBLE AMER 2P+E



TOMACORRIENTE DOBLE UNIVERSAL



JACK TELEFONO SIMPLE RJ25



JACK TELEFONO DOBLE RJ25



JACK DATOS SIMPLE RJ45CAT6A



JACK DATOS DOBLE RJ45CAT6A



COAXIAL 75 OHMS



COAXIAL + JACK TELEFONO

PLURA



TOMACORRIENTE + USB 2.1 AMP



TOMACORRIENTE + USB TIPO C + TIPO A



INTERRUPTOR BIPOLAR 16A I/O CALENTADOR AGUA



TOMACORRIENTE GFCI



TOMA NEMA 6-15



HDMI + TAPA CUBRE HUECO 36 MM

PLURA



DIMMER 400 W



PLACA CIEGA



PULSADOR DE TIMBRE 16 AMP



SENSOR DE MOVIMIENTO (RADAR)



TAPA DE EXTERIORES

PLURA_



MADERA

Ideas Combinaciones



VIDRIO



PLURA_



TERMOPOLIMERO

Ideas Combinaciones

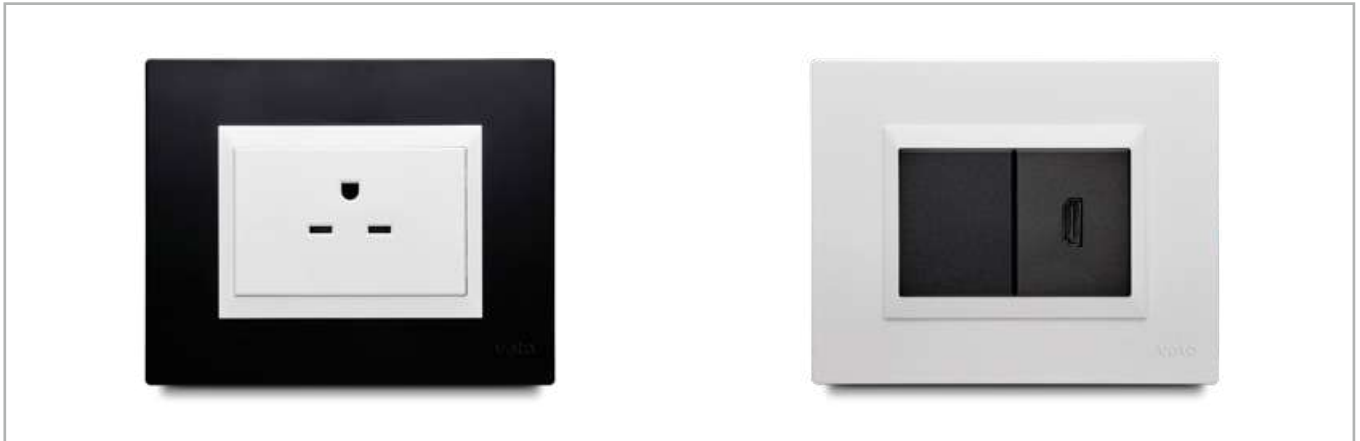

METALES





METALES

Ideas Combinaciones

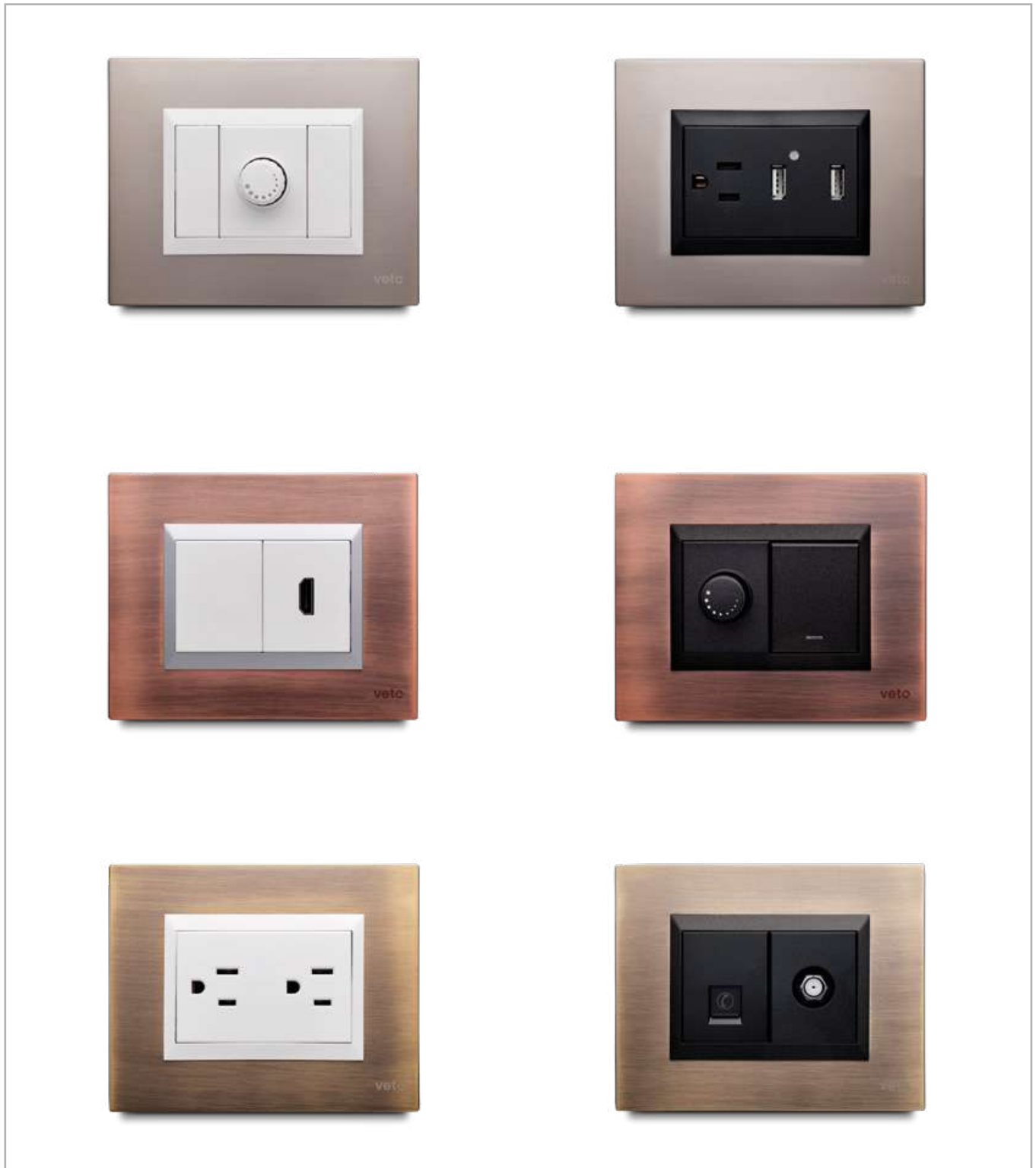

PLURA SMART

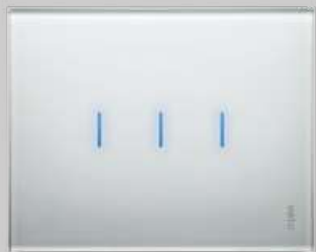

Convierte tu casa
en un lugar inteligente

Tarjeta inteligente

veto® **tuya**™

Compatible con



PLURA SMART_



INTERRUPTORES SMART

- No necesitan cableado de neutro.
- Control desde cualquier parte del mundo.
- Control táctil o remoto a través de teléfono inteligente.
- Fácil de instalar y programar.
- Incluye capacitor (es indispensable la instalación)

CONMUTADORES SMART

- Se acopla a un interruptor inteligente para controlar manualmente el on/off de una luminaria desde dos puntos diferentes.
- Fácil de instalar y programar.
- Control del circuito conmutable desde cualquier parte del mundo gracias a la interacción con el interruptor.

DIMMER SMART

- Permite visualizar en el aplicativo el estado y el nivel de la intensidad de la luz de la luminaria.
- Control táctil o remoto a través de teléfono inteligente.
- Compatible únicamente con luminarias dimerizables.

PLURA SMART_



INTERRUPTOR SIMPLE WIFI



CONMUTADOR SIMPLE RF



INTERRUPTOR DOBLE WIFI



CONMUTADOR DOBLE RF

PLURA SMART_

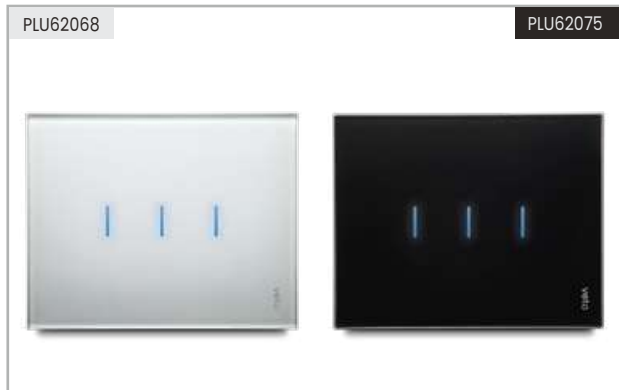

INTERRUPTOR TRIPLE WIFI



CONMUTADOR TRIPLE RF



DIMMER WIFI



PANEL DE CONTROL INTELIGENTE

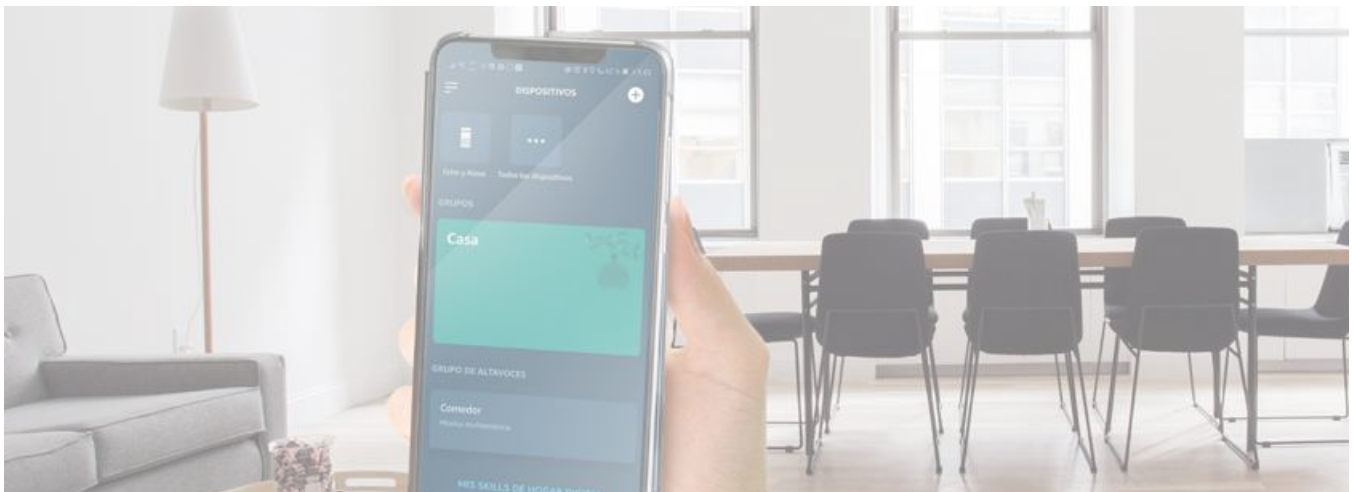

PREMIUM_

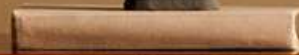

PREMIUM



CARACTERISTICAS

- Sistema modular (Tacos y Placas)
- Bastidor metálico que evita deformaciones
- Interruptores 125/250 Vac 15 Amp
- Tomacorrientes 125/250 Vac 15 Amp
- La luz piloto de nuestros productos no produce destellos al utilizarse con focos ahorradores
- Termopolímero de última generación

CERTIFICACIONES

- Certificación que cumple con la Norma IEC 60669-1 (Interruptores)
- IEC 60884-1 (Tomacorrientes)



DIAGRAMA DE INSTALACION

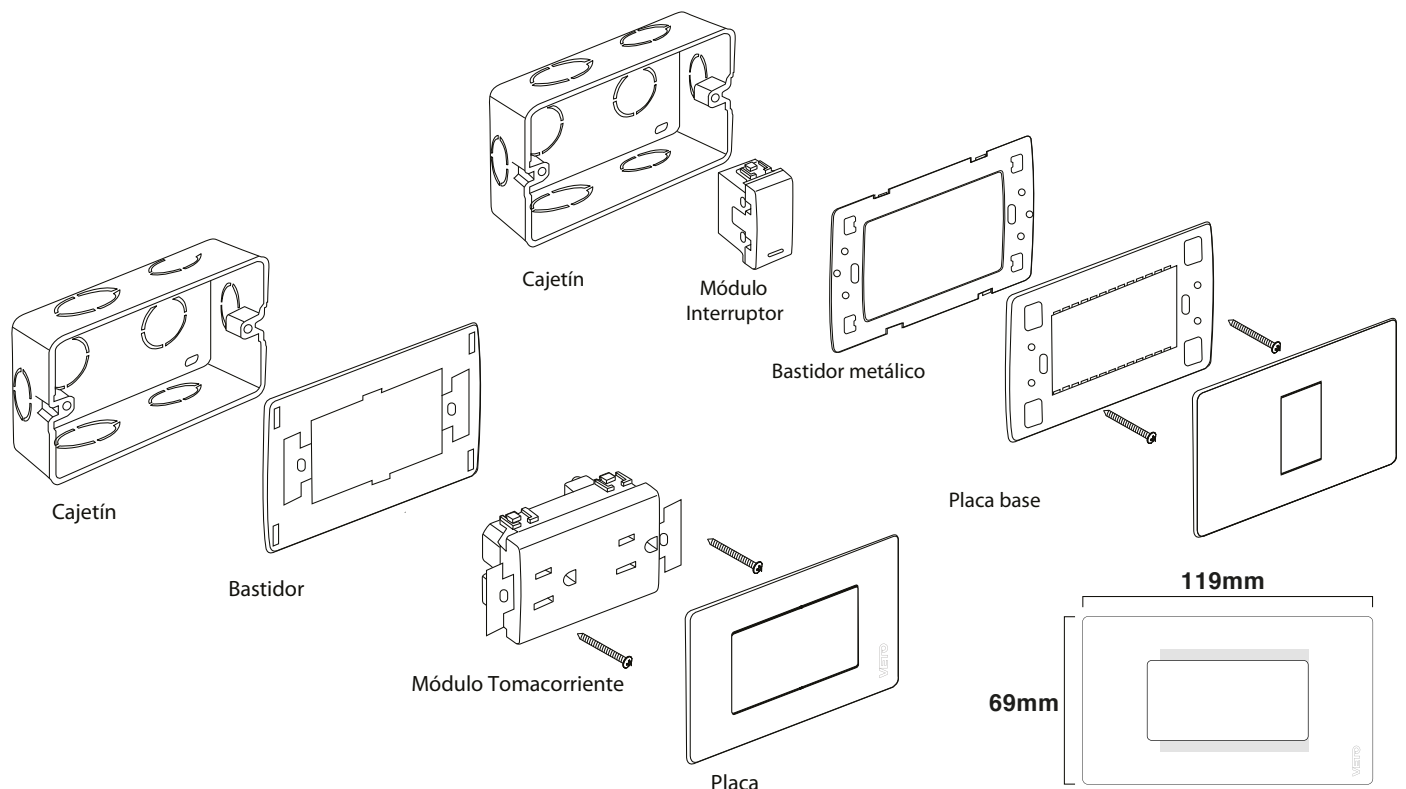

PREMIUM



PREI6405

Placa 1 Hueco - Blanco

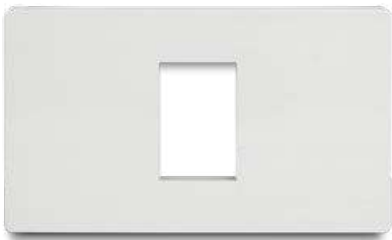

PREI6412

Placa 2 Huecos - Blanco

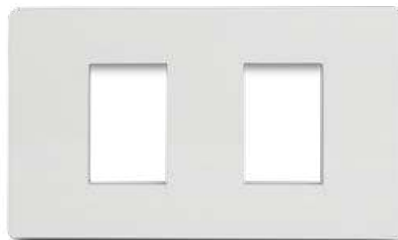

PREI6429

Placa 3 Huecos - Blanco

PREI8973

Placa Tomacorriente - Blanco



PREMIUM STILO

PREI5200

Placa 1 Hueco - Cobre



PREI5217

Placa 2 Huecos - Cobre



PREI5224

Placa 3 huecos - Cobre

PREI5231

Placa Tomacorriente - Cobre



PREI5248

Placa 1 Hueco - Grafito

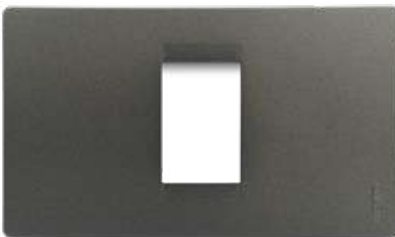

PREI5255

Placa 2 Huecos - Grafito

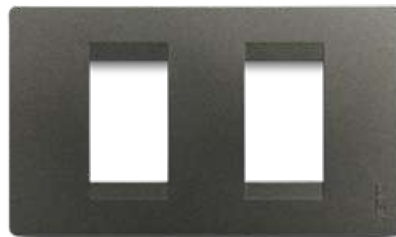

PREI5262

Placa 3 Huecos - Grafito

PREI5279

Placa Tomacorriente - Grafito



PREMIUM

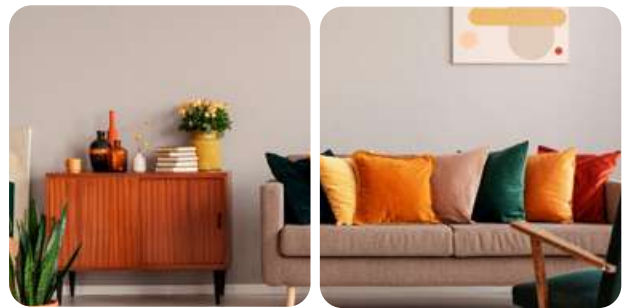

PREMIUM STILO

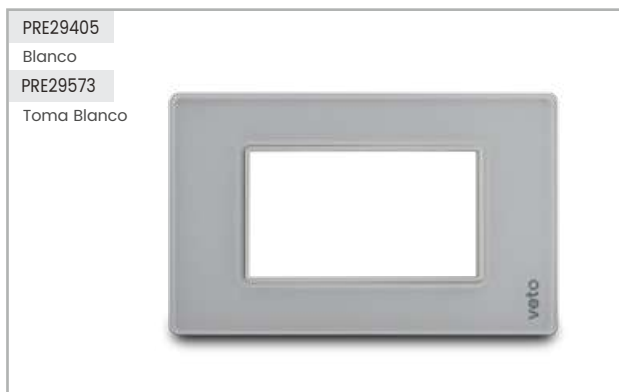

PLACA 3 HUECOS VIDRIO BLANCO



PLACA 3 HUECOS VIDRIO NEGRO



PLACA 3 HUECOS ALUMINIO PLATEADO



PLACA 3 HUECOS ALUMINIO GRAFITO

PREMIUM

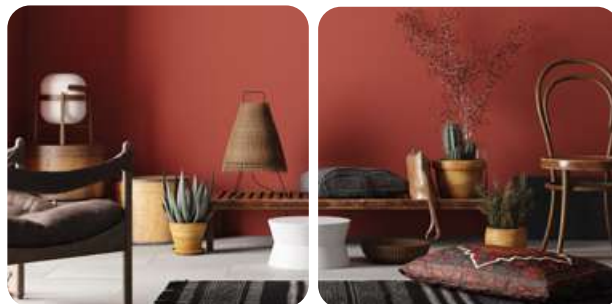

PREMIUM STILO

Placa 6 huecos con bastidor y cajetín

- PLACA BL PRE16436
- PLACA PL PRE15415
- PLACA GR PRE15408
- PLACA CO PRE15392



Módulos

- USB PRE16795
- HDMI PRE16825
- AUDIO PRE16269
- TOMACORRIENTE PRE16191
- JACK TELÉFONO PRE16153

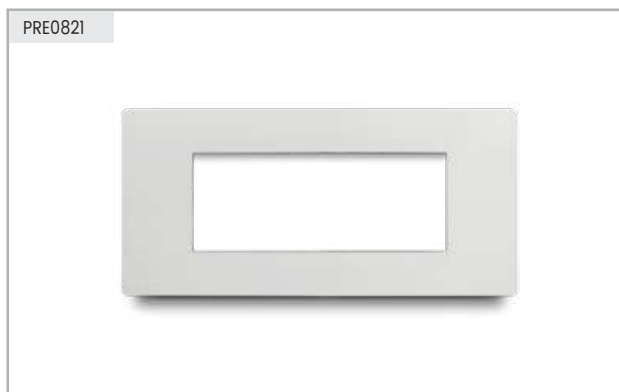

PLACA 4 HUECOS CON BASTIDOR Y CAJETÍN



PLACA MODULAR 1 HUECO - BLANCO



INTERRUPTOR SIMPLE 15 AMP



INTERRUPTOR SIMPLE 15 AMP

PREMIUM

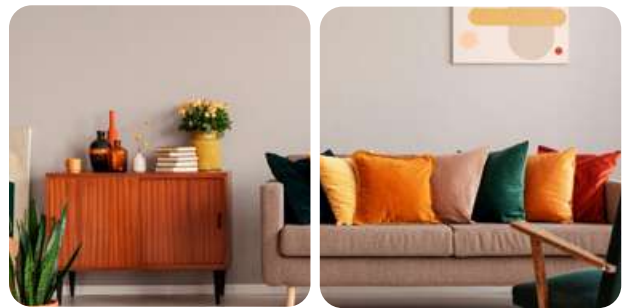

INTERRUPTOR DOBLE 15 AMP



INTERRUPTOR DOBLE 15 AMP



SENSOR DE MOVIMIENTO (RADAR)



INTERRUPTOR TRIPLE 15 AMP



CONMUTADOR SIMPLE 15 AMP



CONMUTADOR SIMPLE 15 AMP

PREMIUM



CONMUTADOR DOBLE 15 AMP



CONMUTADOR DOBLE 15 AMP



INTERRUPTOR + CONMUTADOR 15 AMP



INTERRUPTOR + CONMUTADOR 15 AMP



TOMACORRIENTE GFCI



CONMUTADOR TRIPLE 15 AMP

PREMIUM

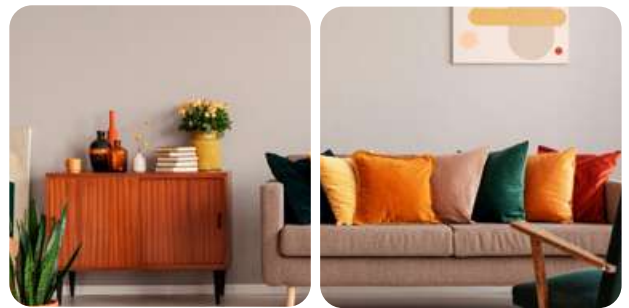

TOMACORRIENTE HEAVY DUTY



CONMUTADOR 4 VIAS SIMPLE 15 AMP

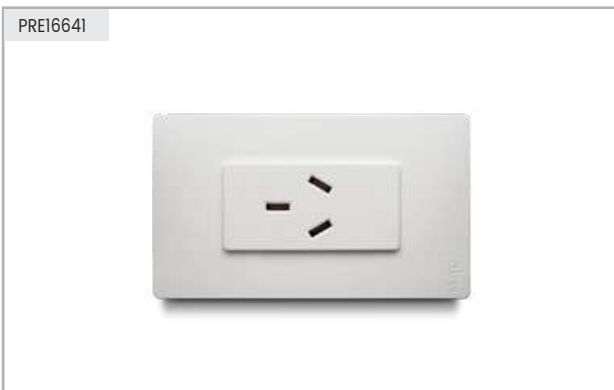

TOMACORRIENTE NEMA 10-20R



CONMUTADOR 4 VIAS SIMPLE 15 AMP



TOMACORRIENTE GRADO HOSPITALARIO



TOMACORRIENTE DOBLE AMER 2P+E

PREMIUM



TOMACORRIENTE CON LUZ DE NOCHE



INTERRUPTOR + TOMACORRIENTE AMER 2P+E



TOMACORRIENTE UNIV + USB



TOMACORRIENTE + USB TIPO C + TIPO A



ZUMBADOR



TOMA USB + TOMACORRIENTE AMER 2P+E

PREMIUM

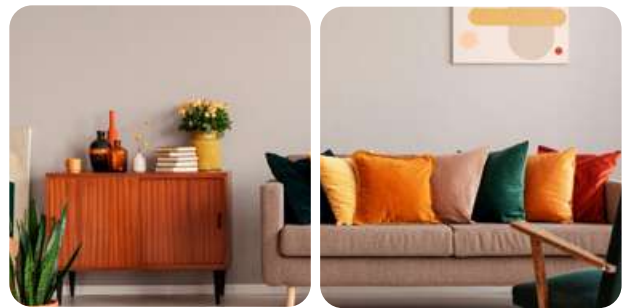

PASACABLE SIMPLE



COAXIAL SIMPLE



JACK TELÉFONO DOBLE



JACK TELÉFONO SIMPLE



JACK DE DATOS DOBLE



JACK DE DATOS SIMPLE

PREMIUM



TARJETERO 30A



PLACA CIEGA

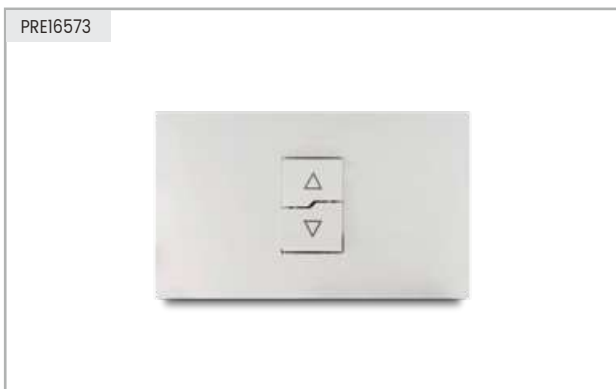

INTERRUPTOR PERSIANAS



PULSADOR TIMBRE



COAXIAL + JACK TELÉFONO



DIMMER 400W

PREMIUM



TOMACORRIENTE NEMA 10-50



TOMACORRIENTE NEMA 10-50



INTERRUPTOR SIMPLE VERTICAL



CONMUTADOR SIMPLE VERTICAL



PULSADOR DE TIMBRE VERTICAL



TOMACORRIENTE DOBLE TIERRA AISLADA

PREMIUM



PREI6276



CONECTOR AUDIO SIMPLE

PREI6283

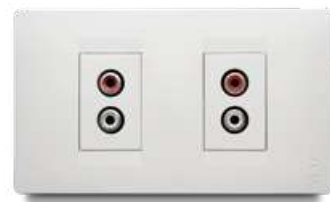

CONECTOR AUDIO DOBLE

PREI6849



TOMACORRIENTE NEMA 6-15A 250V

PREI6757



INTERRUPTOR + TOMACORRIENTE UNIV 2P

PREI6658



TOMACORRIENTE DOBLE UNIV 2P+E

PREI6726



TOMACORRIENTE TRIPLE UNIV 2P

PREMIUM



PRE28835



TAPA DE EXTERIORES CON GFCI

PRE16672



TAPA EXTERIORES

PRE30814



TOMACORRIENTE NEMA 1450

PRE16078



INTERRUPTOR

PRE16122



CONMUTADOR

PRE16139



CONMUTADOR 4 VÍAS

PREMIUM



TOMACORRIENTE



HDMI



TAPA CUBRE HUECO



DIMMER 400W



JACK DE DATOS RJ45 CAT6



ZUMBADOR

PREMIUM



PREI6795



USB

PRE30456



USB A+C

PREI6320



COAXIAL

PREI6153



JACK TELÉFONO RJ14

PREI6566



INTERRUPTOR PERSIANAS

PREMIUM SMART



Tarjeta inteligente



Compatible con



PREMIUM SMART



INTERRUPTORES SMART

No necesitan cableado de neutro.

Control desde cualquier parte del mundo.

Control táctil o remoto a través de teléfono inteligente.

Fácil de instalar y programar.

Incluye capacitor (es indispensable la instalación)

CONMUTADORES SMART

Se acopla a un interruptor inteligente para controlar manualmente el on/off de una luminaria desde dos puntos diferentes.

Fácil de instalar y programar.

Control del circuito conmutable desde cualquier parte del mundo gracias a la interacción con el interruptor.

DIMMER SMART

Permite visualizar en el aplicativo el estado y el nivel de la intensidad de la luz de la luminaria.

Control táctil o remoto a través de teléfono inteligente.

Compatible únicamente con luminarias dimerizables.

PREMIUM SMART



INTERRUPTOR SIMPLE WIFI



CONMUTADOR SIMPLE



INTERRUPTOR DOBLE WIFI

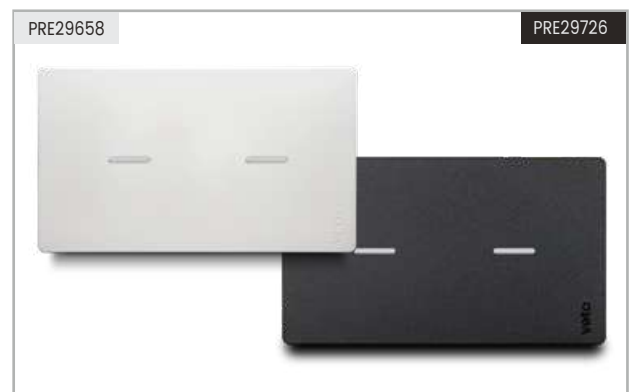

CONMUTADOR DOBLE

PREMIUM SMART

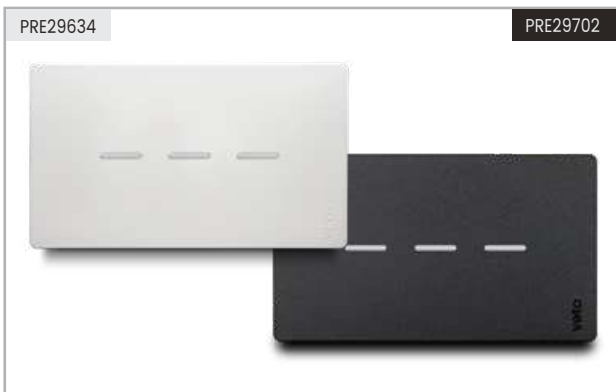

INTERRUPTOR TRIPLE WIFI

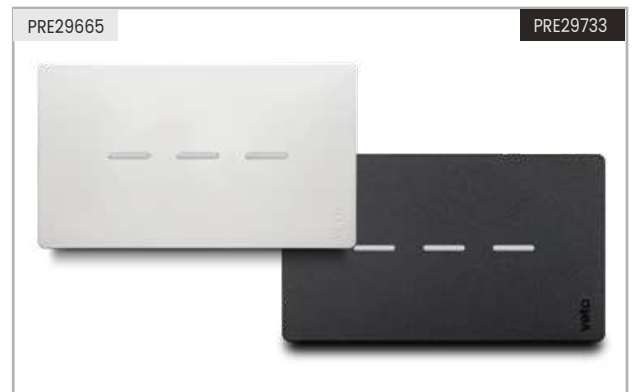

CONMUTADOR TRIPLE



DIMMER WIFI



PANEL DE CONTROL INTELIGENTE

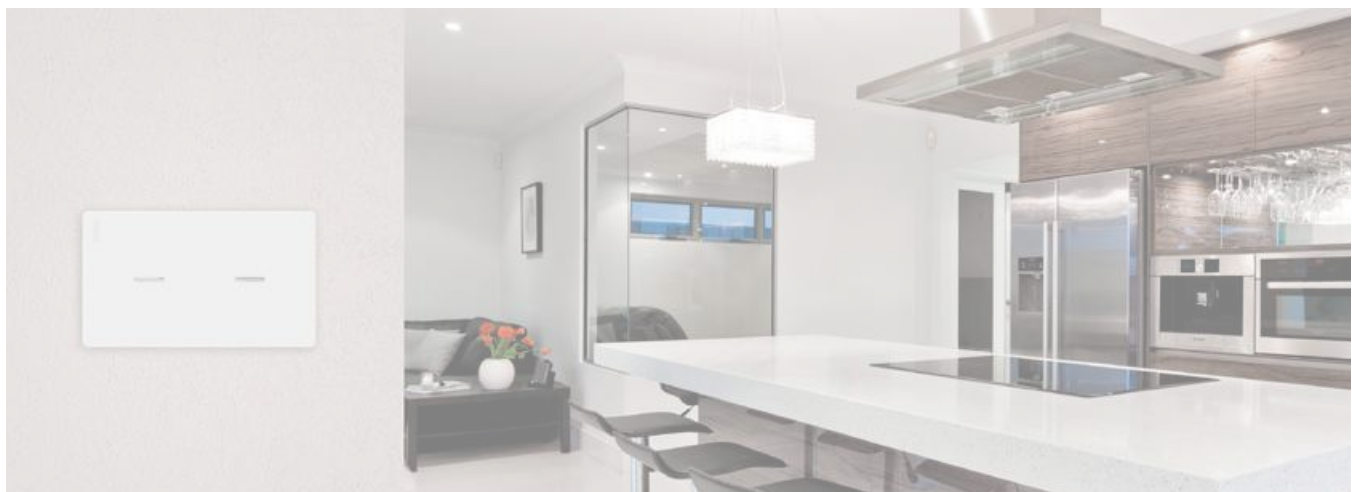

PLATA



PLATA



CARACTERISTICAS

Sistema modular (Tacos y Placas)
Contactos con punto de Plata
Interruptores 125/250 Vac 10 Amp
Tomacorrientes 125/250 Vac 15 Amp
La luz de nuestros productos no produce destellos al utilizarse con focos ahorradores
Fabricado en Termopolímero de última generación

CERTIFICACIONES

Certificación que cumple con la Norma
IEC 60669-1 (Interruptores)
IEC 60884-1 (Tomacorrientes)



DIAGRAMA DE INSTALACION

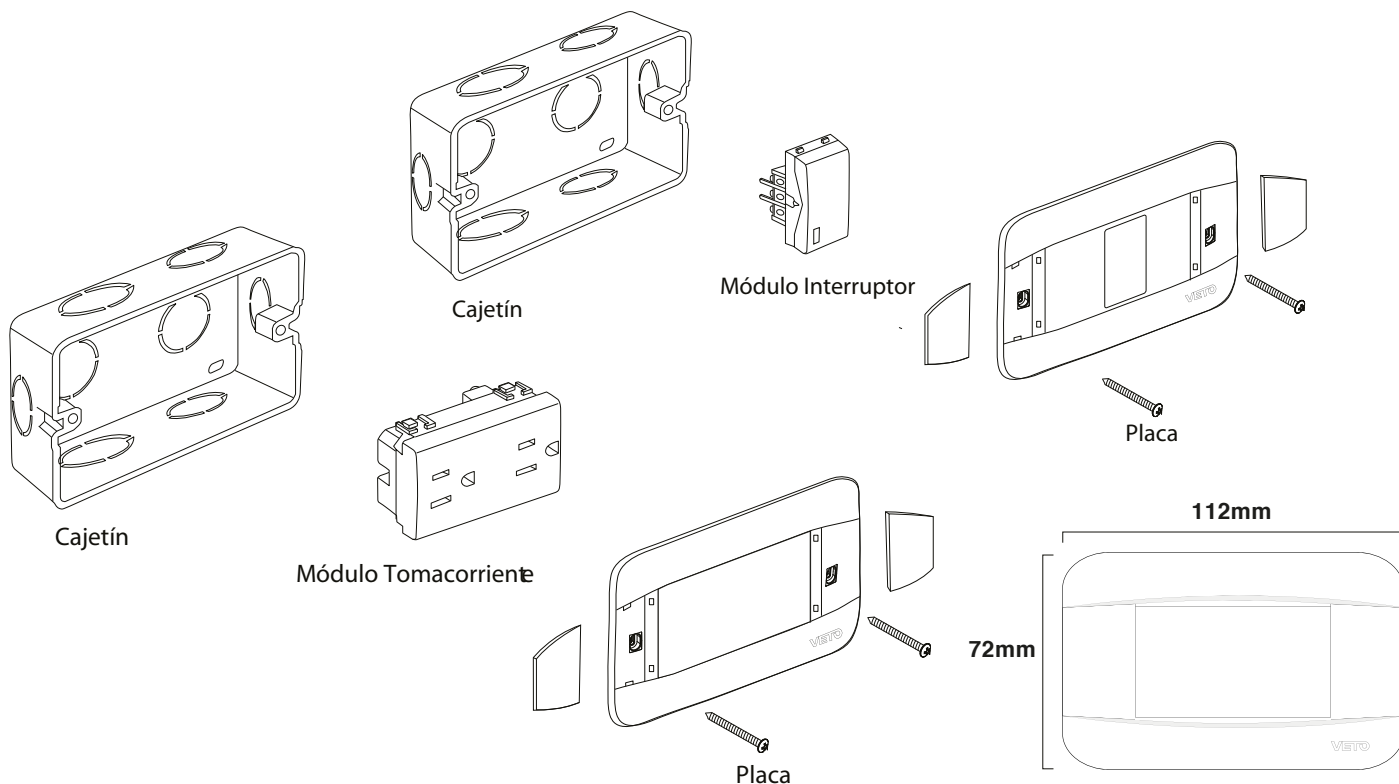

PLATA_



INTERRUPTOR SIMPLE CON LUZ 10AMP



INTERRUPTOR SIMPLE CON LUZ 10AMP

PLATA_



PLA35123

PLA35130

INTERRUPTOR DOBLE CON LUZ 10AMP

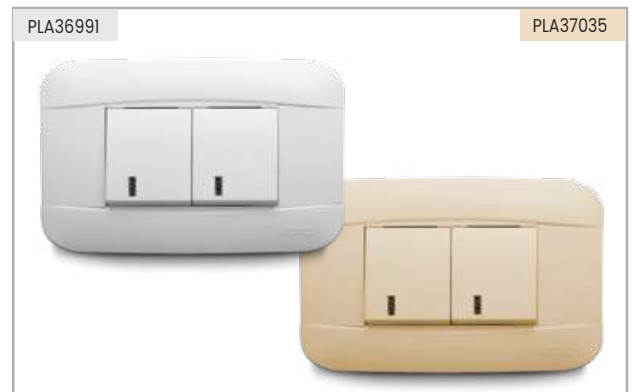

PLA36991

PLA37035

INTERRUPTOR DOBLE CON LUZ 10AMP

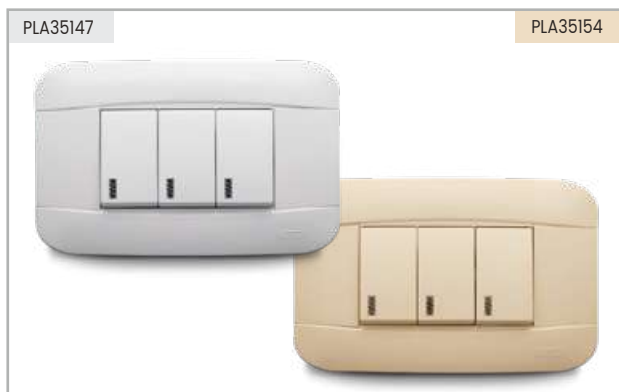

PLA35147

PLA35154

INTERRUPTOR TRIPLE CON LUZ 10AMP



PLA35246

PLA35680

CONMUTADOR TRIPLE CON LUZ 10AMP



PLA35208

PLA35215

CONMUTADOR SIMPLE CON LUZ 10AMP



PLA37066

PLA37103

CONMUTADOR SIMPLE CON LUZ 10AMP

PLATA_



CONMUTADOR DOBLE CON LUZ 10AMP

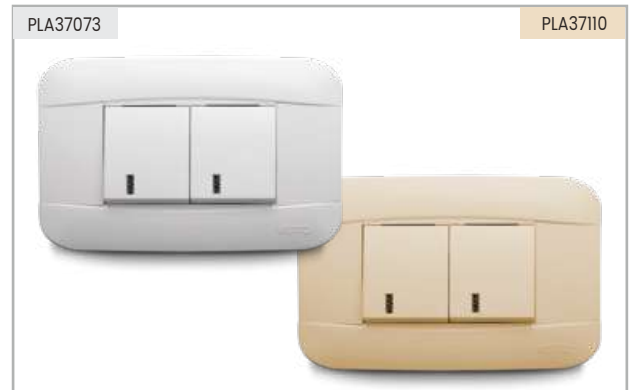

CONMUTADOR DOBLE CON LUZ 10AMP



INTERRUPTOR + CONMUTADOR CON LUZ

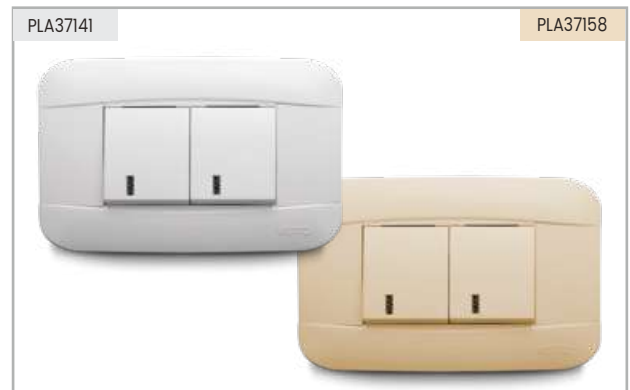

INTERRUPTOR + CONMUTADOR CON LUZ



PULSADOR DE TIMBRE CON LUZ



PULSADOR DE TIMBRE CON LUZ

PLATA



PLA89997

PLA90160

INTERRUPTOR SIMPLE 10AMP

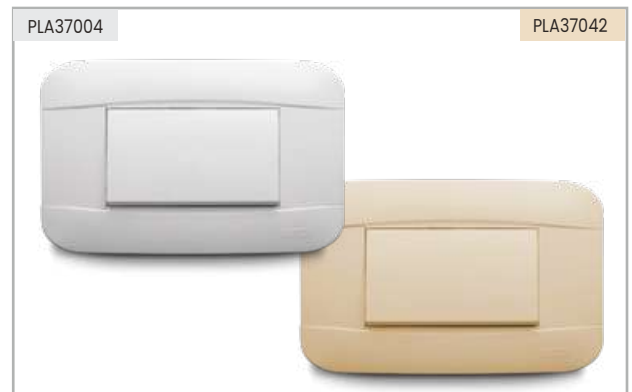

PLA37004

PLA37042

INTERRUPTOR SIMPLE 10AMP

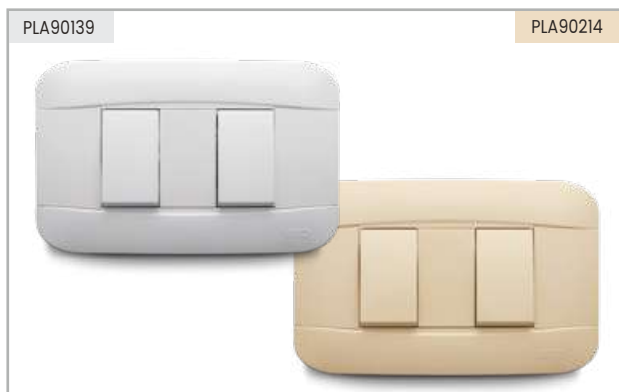

PLA90139

PLA90214

INTERRUPTOR DOBLE 10AMP

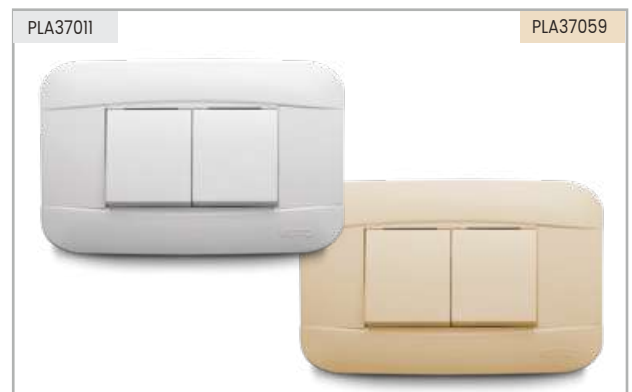

PLA37011

PLA37059

INTERRUPTOR DOBLE 10AMP

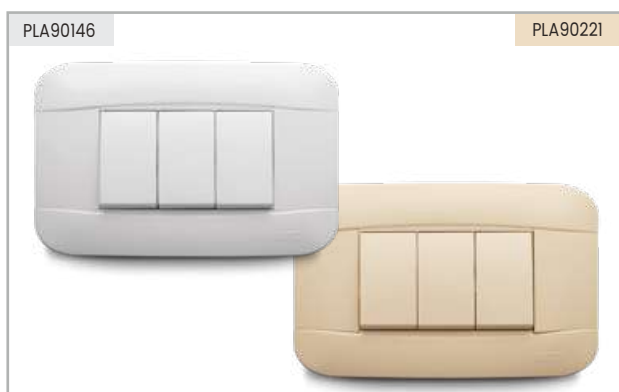

PLA90146

PLA90221

INTERRUPTOR TRIPLE 10AMP

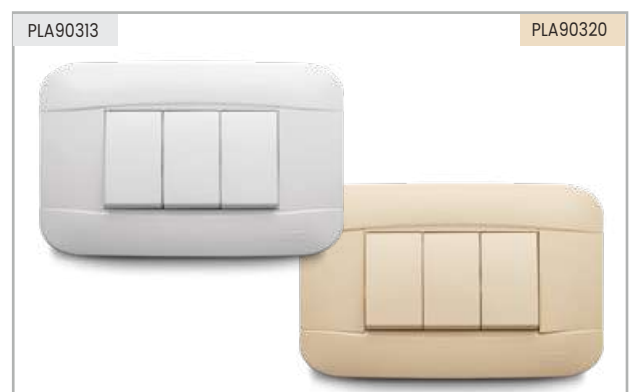

PLA90313

PLA90320

CONMUTADOR TRIPLE 10AMP

PLATA_



CONMUTADOR SIMPLE 10AMP



CONMUTADOR SIMPLE 10AMP

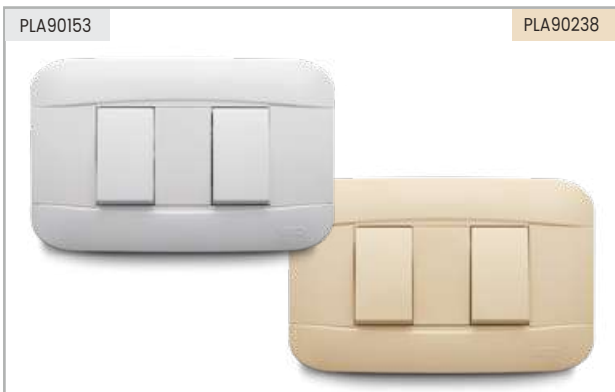

CONMUTADOR DOBLE 10AMP

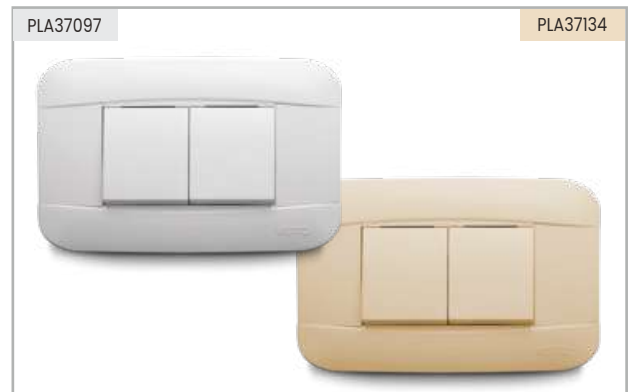

CONMUTADOR DOBLE 10AMP

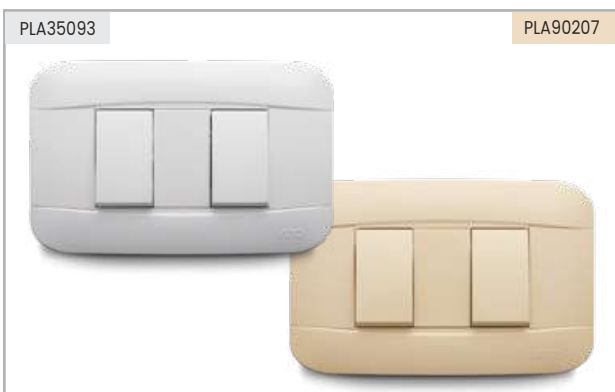

INTERRUPTOR + CONMUTADOR

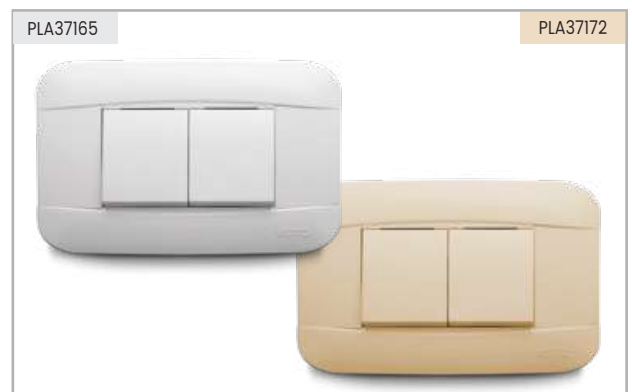

INTERRUPTOR + CONMUTADOR

PLATA_



PLA35598

PLA35727

TOMACORRIENTE AMER 2P+E + INTERRUPTOR CON LUZ



PLA90122

PLA90191

TOMACORRIENTE AMER 2P+E + INTERRUPTOR



PLA35352

PLA35369

TOMACORRIENTE DOBLE AMER 2P+E



PLA36700

PLA36717

TOMACORRIENTE TRIPLE AMER 2P+E



PLA35284

PLA35277

JACK TELÉFONO SIMPLE RJ14



PLA35307

PLA35291

JACK TELÉFONO DOBLE RJ14

PLATA_



PLA90443



TOMACORRIENTE DOBLE TIERRA AISLADA

PLA90115

PLA90184



PULSADOR DE TIMBRE

PLA35314

PLA35765



COAXIAL + JACK TELÉFONO

PLA35475

PLA35468



COAXIAL 65 OHMS

PLA35383

PLA35697



JACK DATOS SIMPLE CAT6

PLA35390

PLA35703



JACK DATOS DOBLE CAT6

PLATA_



TOMACORRIENTE NEMA 6-15R



TOMACORRIENTE DOBLE GFCI



TOMACORRIENTE UNIV 2P + USB



TOMACORRIENTE + USB 2.1AMP



TOMACORRIENTE SIMPLE UNIV 2P



TOMACORRIENTE DOBLE UNIV 2P

PLATA_



PLA35895

PLA35956

TOMACORRIENTE UNIV 2P + INTERRUPTOR



PLA35826

PLA35840

TOMACORRIENTE DOBLE UNIV 2P+E



PLA35888

PLA35871

TOMACORRIENTE UNIV 2P+E + INTERRUPTOR

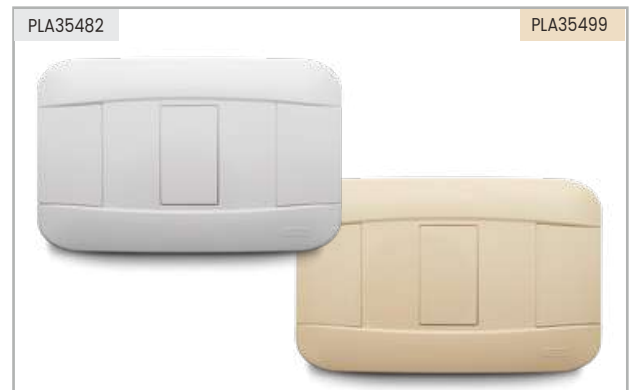

PLA35482

PLA35499

PLACA CIEGA



PLA35789

PLA35802

CONECTOR PARLANTE SIMPLE



PLA35796

PLA35819

CONECTOR PARLANTE DOBLE

PLATA_

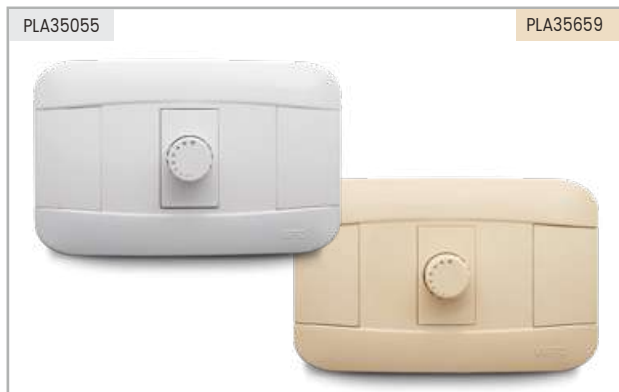

DIMMER 200W



PASACABLE SIMPLE



TOMACORRIENTE SHUKO 16 AMP



TOMACORRIENTE SIMPLE ITALIANO 2P+E

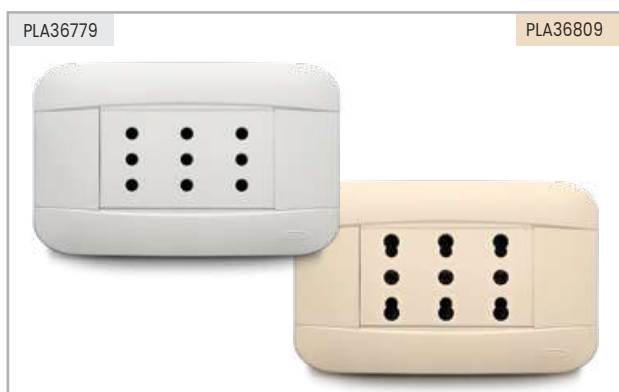

TOMACORRIENTE TRIPLE ITALIANO 2P+E



TOMACORRIENTE AMER 2P+E

PLATA_



INTERRUPTOR CON LUZ 10 AMP



INTERRUPTOR 10 AMP



CONMUTADOR CON LUZ 10 AMP



CONMUTADOR 10 AMP



PULSADOR DE TIMBRE CON LUZ 10 AMP



PULSADOR DE TIMBRE 10 AMP

PLATA



JACK TELEFONO RJ14



JACK DATOS CAT6

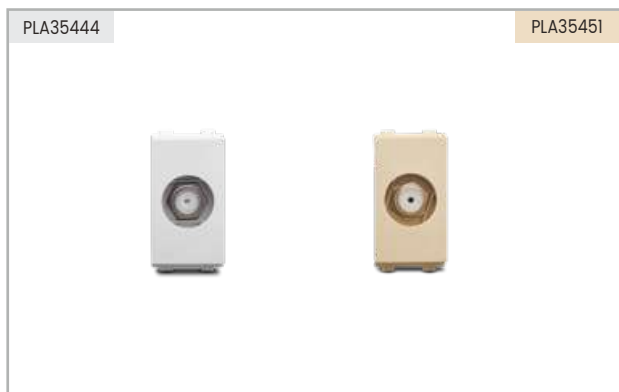

COAXIAL 65 OHMS



DIMMER



TAPA CUBRE HUECO

VIVE_





CARACTERISTICAS

Sistema modular (Tacos y Placas)
 Interruptores 125/250 Vac 10 Amp
 Tomacorrientes 125/250 Vac 15 Amp

CERTIFICACIONES

Certificación que cumple con la Norma
 IEC 60669-1 (Interruptores)
 IEC 60884-1 (Tomacorrientes)



DIAGRAMA DE INSTALACION

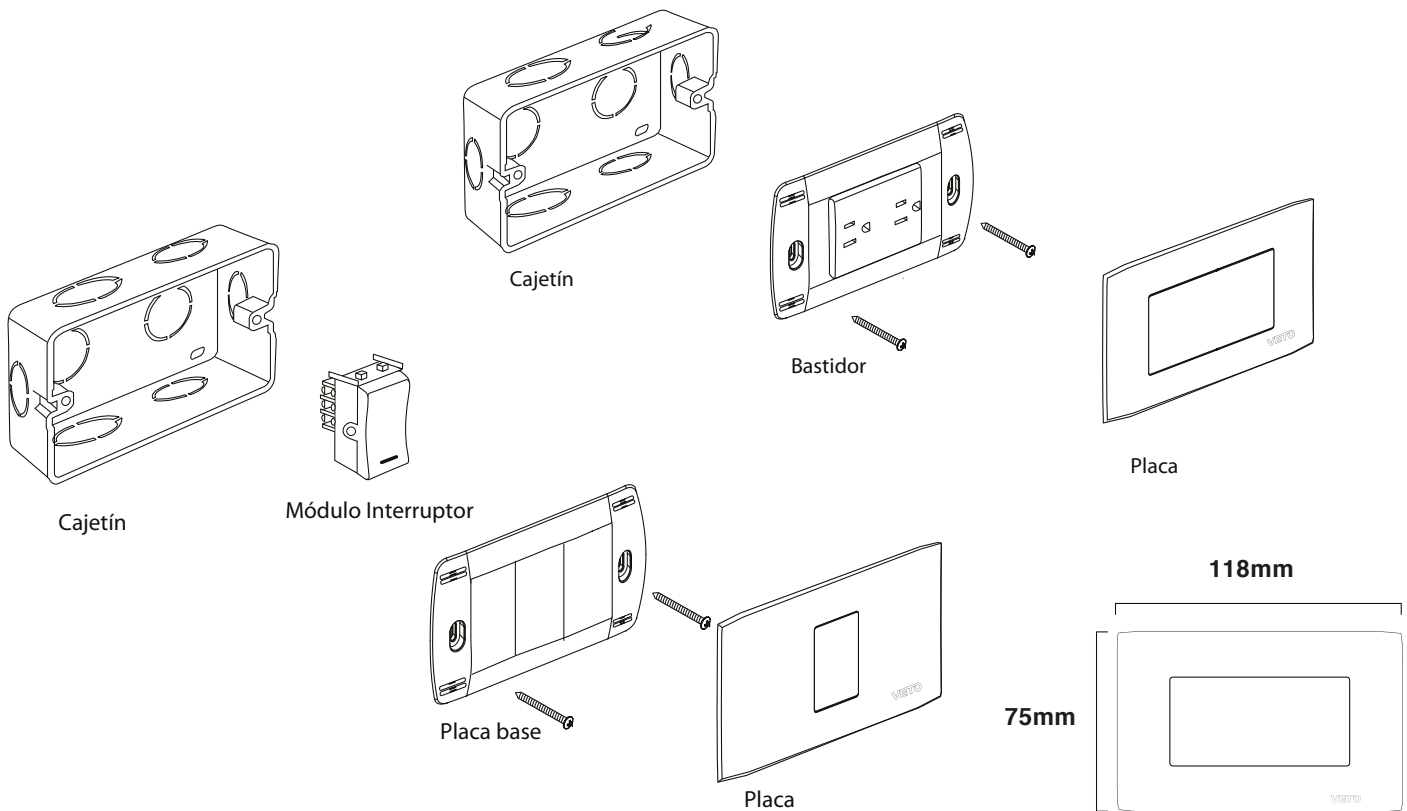

VIVE_

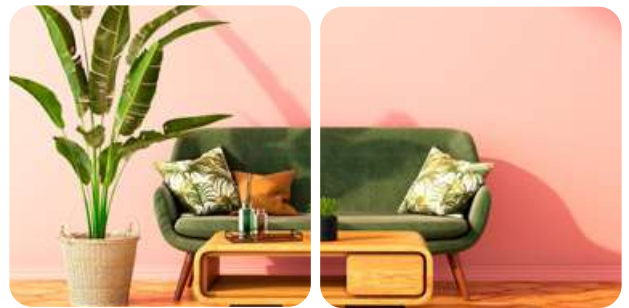

VIV13701

Placa 1 Hueco - Blanco



VIV13718

Placa 2 Huecos - Blanco

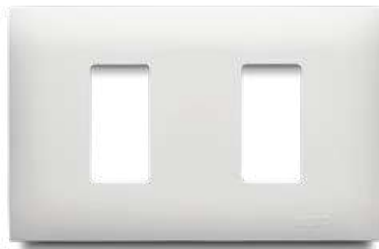

VIV13725

Placa 3 Huecos - Blanco

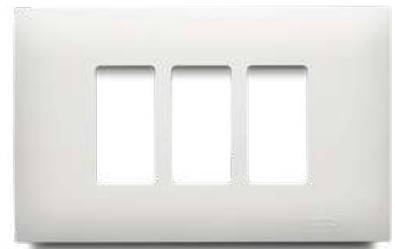

VIV14074

Placa 1 Hueco - Marfil



VIV14081

Placa 2 Huecos - Marfil



VIV14098

Placa 3 Huecos - Marfil

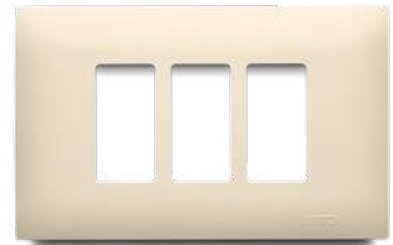

VIV13008

VIV13237



INTERRUPTOR SIMPLE CON LUZ 10AMP

VIV14463

VIV19376



INTERRUPTOR SIMPLE CON LUZ 10AMP

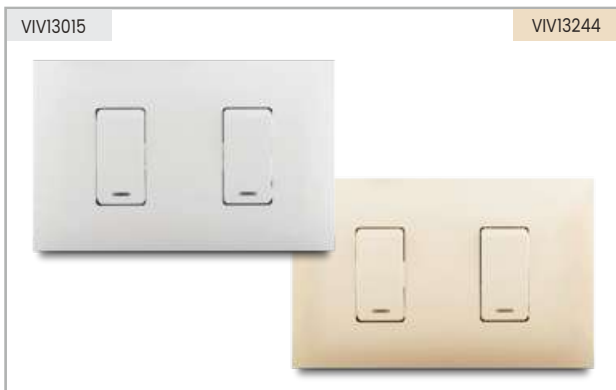

INTERRUPTOR DOBLE CON LUZ 10 AMP



INTERRUPTOR DOBLE CON LUZ 10 AMP

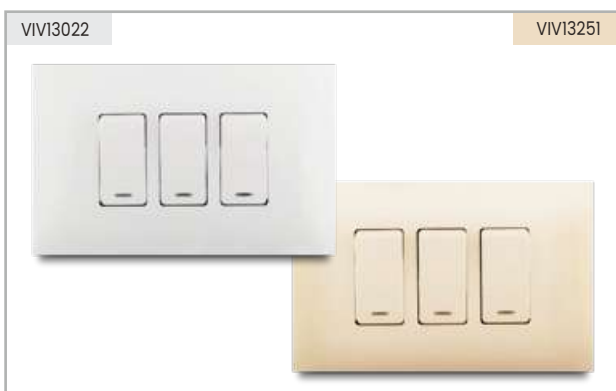

INTERRUPTOR TRIPLE CON LUZ 10 AMP

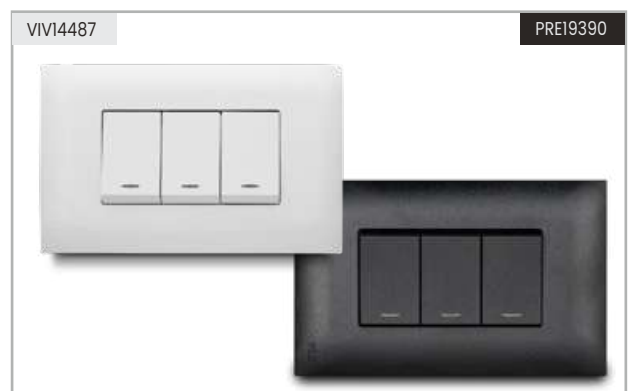

INTERRUPTOR TRIPLE CON LUZ 10 AMP



CONMUTADOR SIMPLE CON LUZ 10 AMP



CONMUTADOR SIMPLE CON LUZ 10 AMP

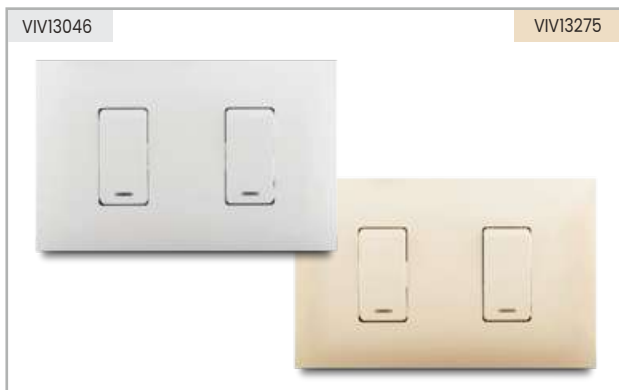

CONMUTADOR DOBLE CON LUZ 10 AMP



CONMUTADOR DOBLE CON LUZ 10 AMP

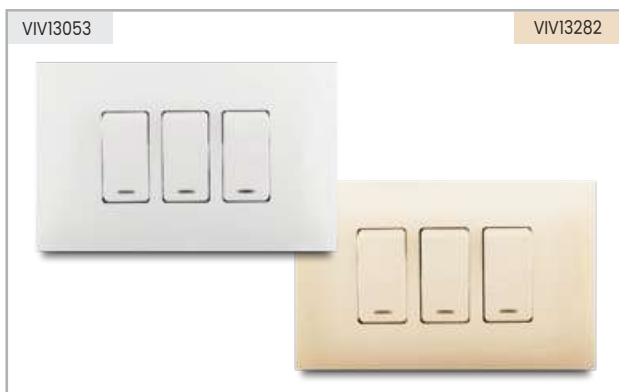

CONMUTADOR TRIPLE CON LUZ 10 AMP



CONMUTADOR TRIPLE CON LUZ 10 AMP

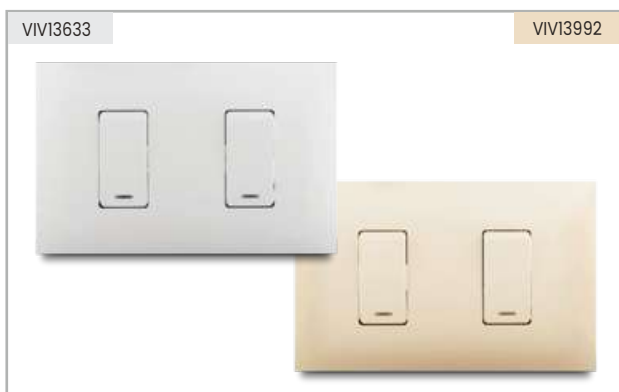

INTERRUPTOR + CONMUTADOR CON LUZ



TOMACORRIENTE DOBLE AMER 2P+E



TOMACORRIENTE + INTERRUPTOR CON LUZ



TOMACORRIENTE AMER 2P+E + INTERRUPTOR CON LUZ

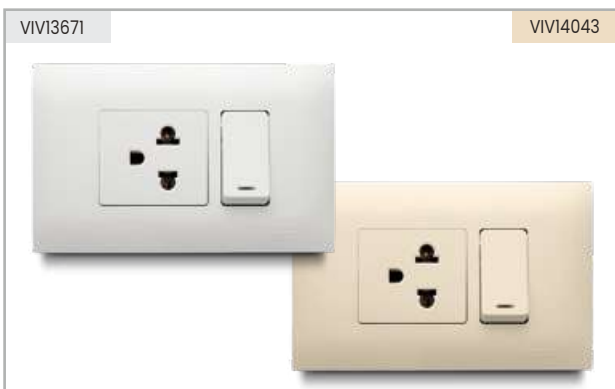

TOMACORRIENTE UNIV 2P+E + INTERRUPTOR CON LUZ



PULSADOR DE TIMBRE CON LUZ



TOMACORRIENTE UNIV 2P + INTERRUPTOR CON LUZ



JACK TELÉFONO SIMPLE RJ14

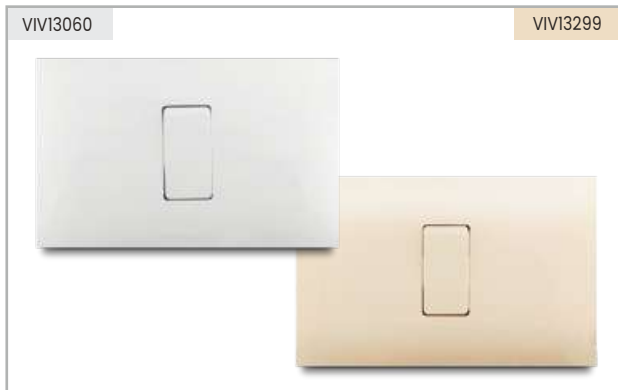
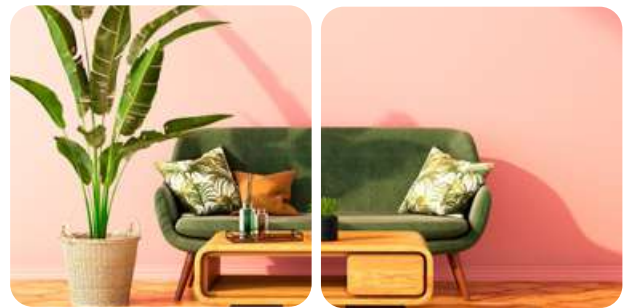

INTERRUPTOR SIMPLE



JACK DATOS SIMPLE CAT6

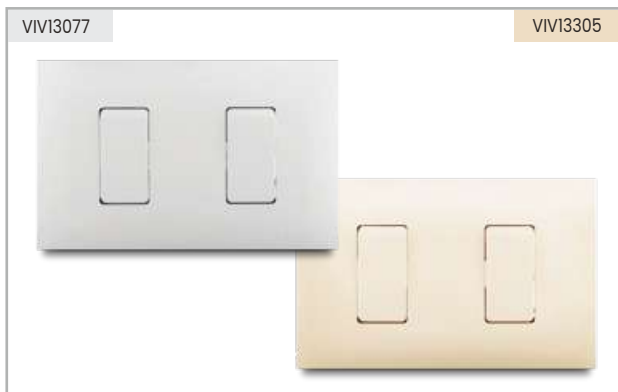

INTERRUPTOR DOBLE



USB + TOMACORRIENTE AMER 2P+E

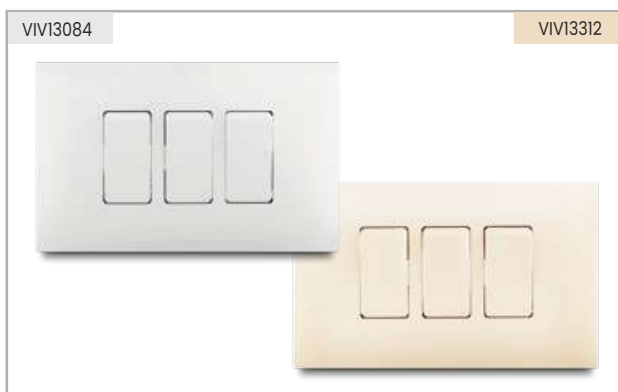

INTERRUPTOR TRIPLE



COAXIAL 75 OHMS

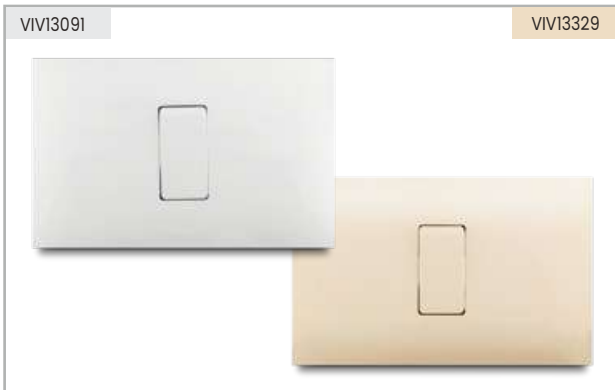

CONMUTADOR SIMPLE



PLACA CIEGA

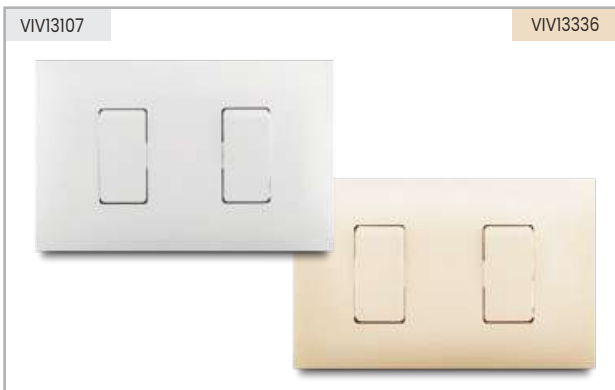

CONMUTADOR DOBLE

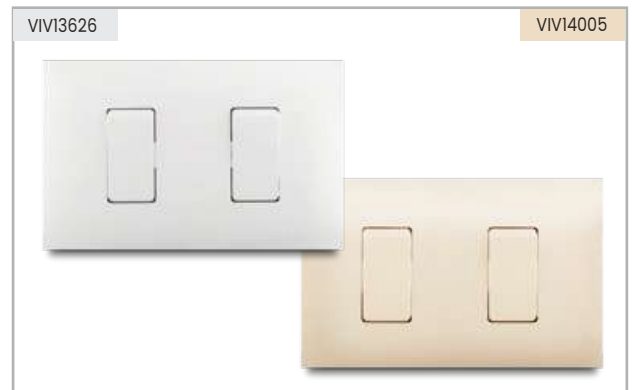

INTERRUPTOR + CONMUTADOR



CONMUTADOR TRIPLE



INTERRUPTOR + CONMUTADOR CON LUZ



TOMACORRIENTE AMER 2P+E + INTERRUPTOR



TOMACORRIENTE UNIV 2P + INTERRUPTOR

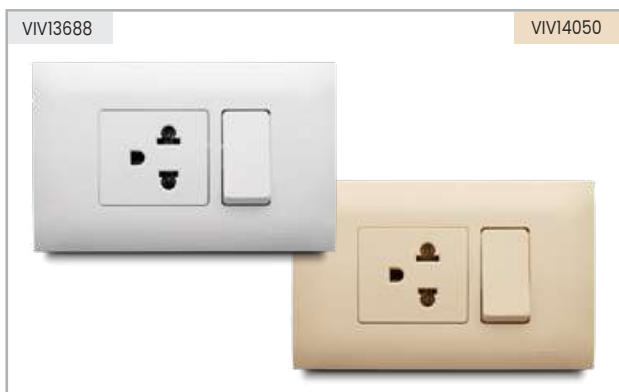

TOMACORRIENTE UNIV 2P+E + INTERRUPTOR



TOMACORRIENTE UNIV 2P SIMPLE



TOMACORRIENTE UNIV 2P DOBLE



TOMACORRIENTE UNIV 2P+E DOBLE

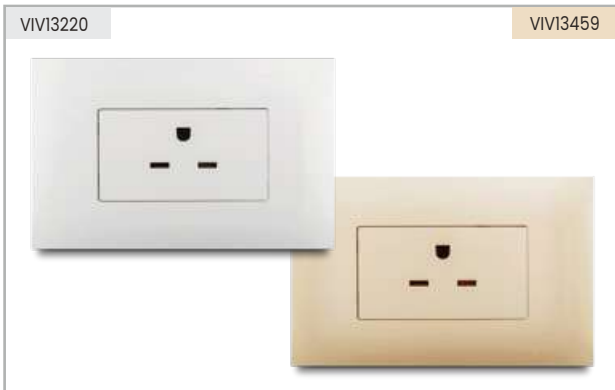

TOMACORRIENTE NEMA 6-15R



TOMACORRIENTE DOBLE GFCI 15A



TOMACORRIENTE DOBLE TIERRA AISLADA



COAXIAL + JACK TELÉFONO



CONECTOR PARLANTE SIMPLE

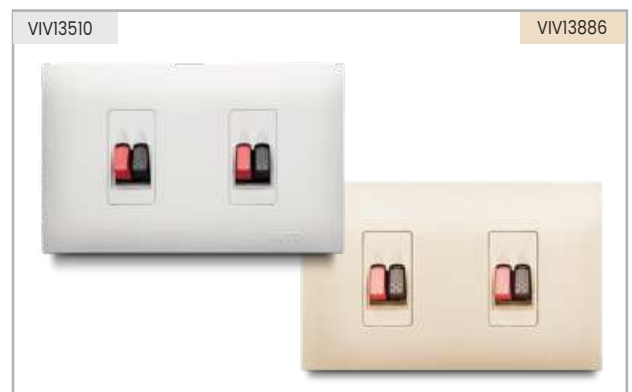

CONECTOR PARLANTE DOBLE

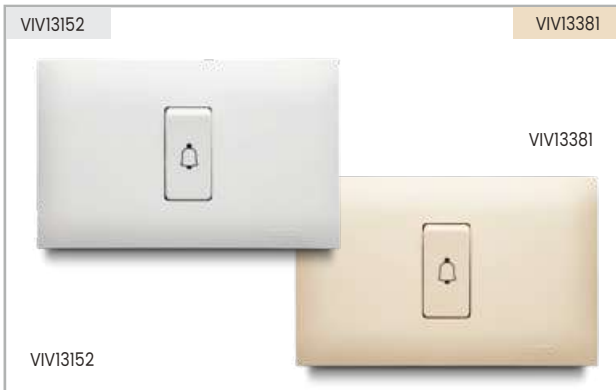
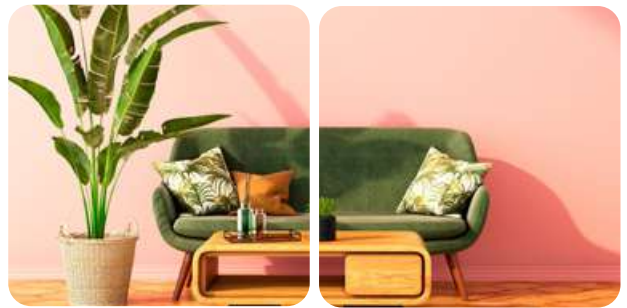

PULSADOR DE TIMBRE



PULSADOR DE TIMBRE



JACK TELÉFONO DOBLE RJ14



JACK DATOS DOBLE CAT6



DIMMER 200W



ZUMBADOR



PASACABLE

VIVE BASIC



INTERRUPTOR SIMPLE 10 AMP



CONMUTADOR SIMPLE 10 AMP

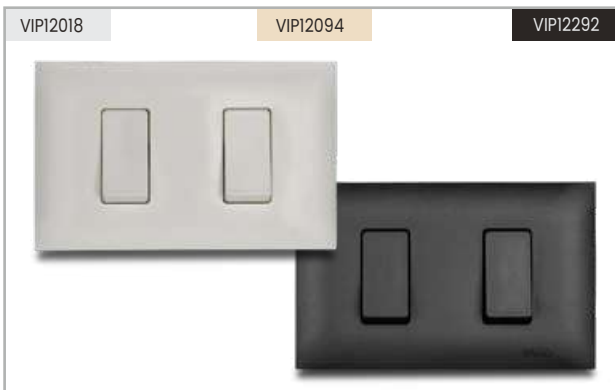

INTERRUPTOR DOBLE 10 AMP

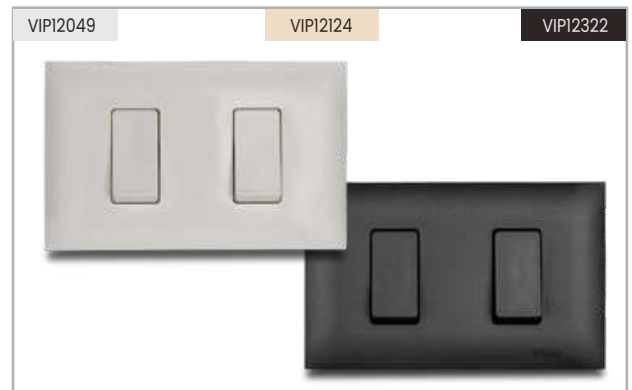

CONMUTADOR DOBLE 10 AMP

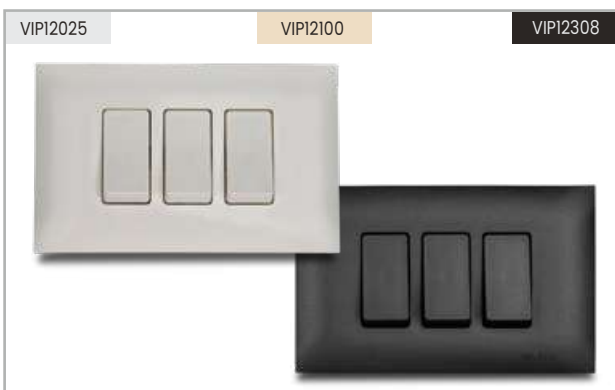

INTERRUPTOR TRIPLE 10 AMP

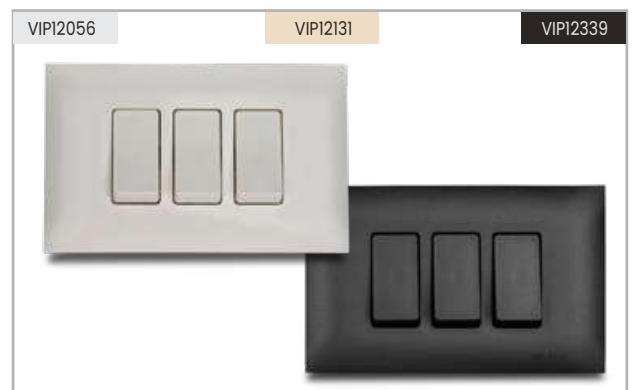

CONMUTADOR TRIPLE 10 AMP

VIVE BASIC



INTERRUPTOR + TOMACORRIENTE AMER 2P+E

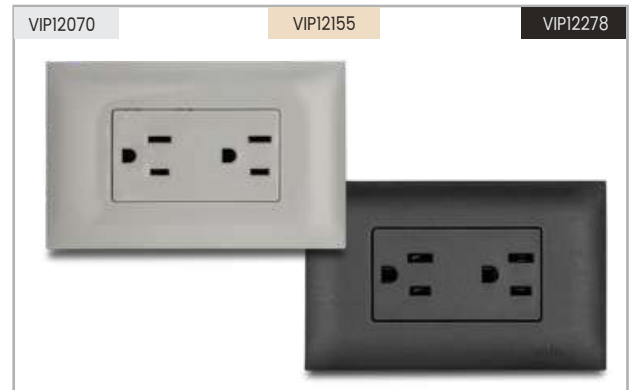

TOMACORRIENTE DOBLE AMER 2P+E



TOMACORRIENTE UNIV 2P+E DOBLE



JACK TELEFONO RJ14 SIMPLE



COAXIAL SIMPLE



JACK DATOS RJ45 CAT6 SIMPLE

VIVE BASIC



PLACA CIEGA CON BASTIDOR



ZUMBADOR SIMPLE



TOMACORRIENTE DOBLE GFCI 15A



PULSADOR DE TIMBRE SIMPLE

CLICK_



CLICK



CARACTERISTICAS

Soluciones sobrepuestas
Contactos con punto de Plata
Interruptores 125/250 Vac 10 Amp
Pulsadores 125/250 Vac 10 Amp
Conmutadores 125/250 Vac 10 Amp
Tomacorrientes 125/250 Vac 15 Amp

CERTIFICACIONES

Certificación que cumple con la Norma
IEC 60669-1 (Interruptores)
IEC 60884-1 (Tomacorrientes)

DIAGRAMA DE INSTALACION

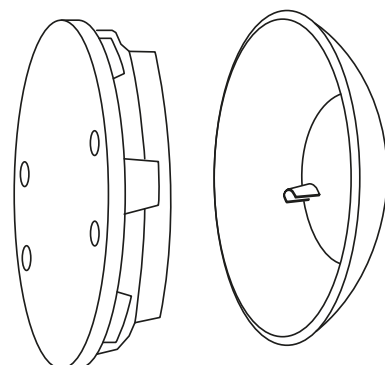
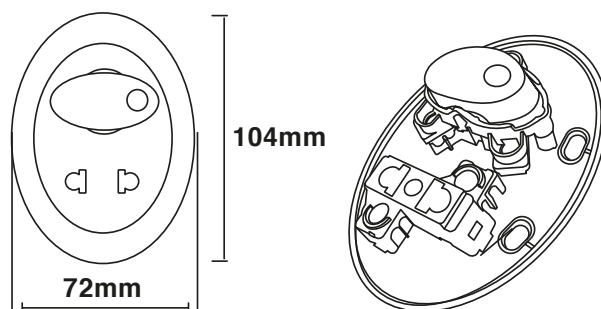
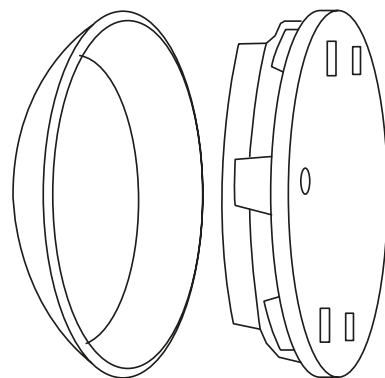
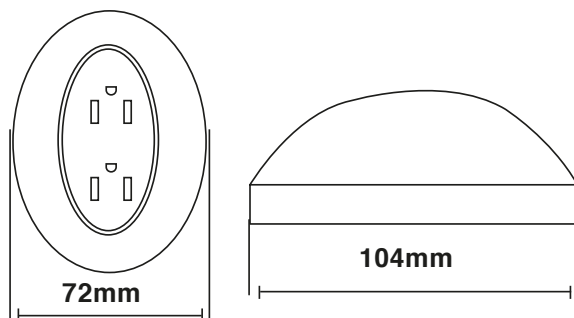

CLICK



INTERRUPTOR SIMPLE



CONMUTADOR SIMPLE



PULSADOR DE TIMBRE



TOMACORRIENTE DOBLE AMER 2P+E

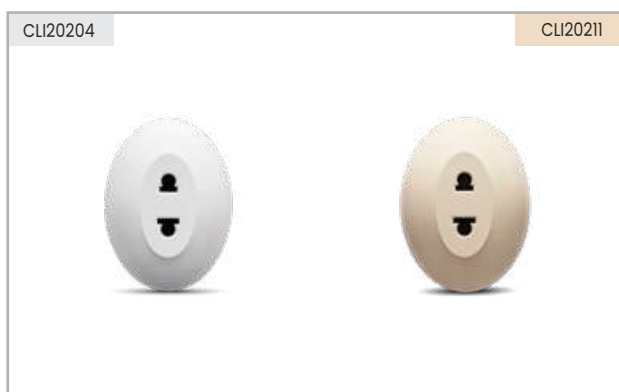

TOMACORRIENTE SIMPLE UNIV 2P



INTERRUPTOR 20 AMP

CLICK



TOMACORRIENTE DOBLE UNIV 2P+E

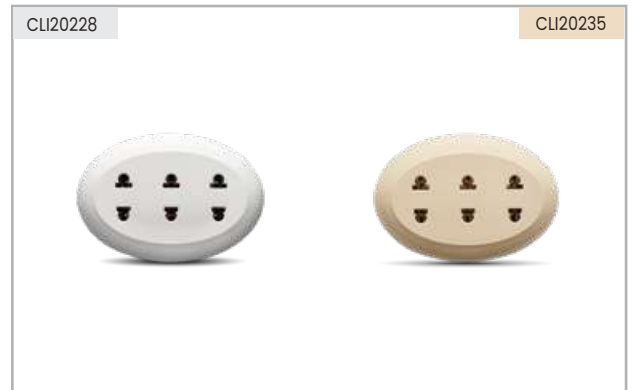

TOMACORRIENTE UNIV TRIPLE 2P



TOMACORRIENTE UNIV 2P + INTERRUPTOR

ACCESORIOS



ACCESORIOS



PORTALÁMPARA/PLAFÓN



PORTALÁMPARA/PLAFÓN LED



CLAVIJA 50 AMP



BOQUILLA



CLAVIJA 1450 50 AMP



CLAVIJA 20 AMP

ACCESORIOS



DING DONG KINETICO 110-250V



PANEL DE CONTROL INTELIGENTE



SOCKET DE PISO TL



SOCKET DE PISO



ADAPTADOR



SOCKET DE PISO

ACCESORIOS



DING DONG



CONECTOR RAPIDO PCT 2-2



CONECTOR RAPIDO PCT 2-3



CONECTOR RAPIDO PCT 212



CONECTOR RAPIDO PCT 213



CONECTOR RAPIDO PCT 211

POWER_

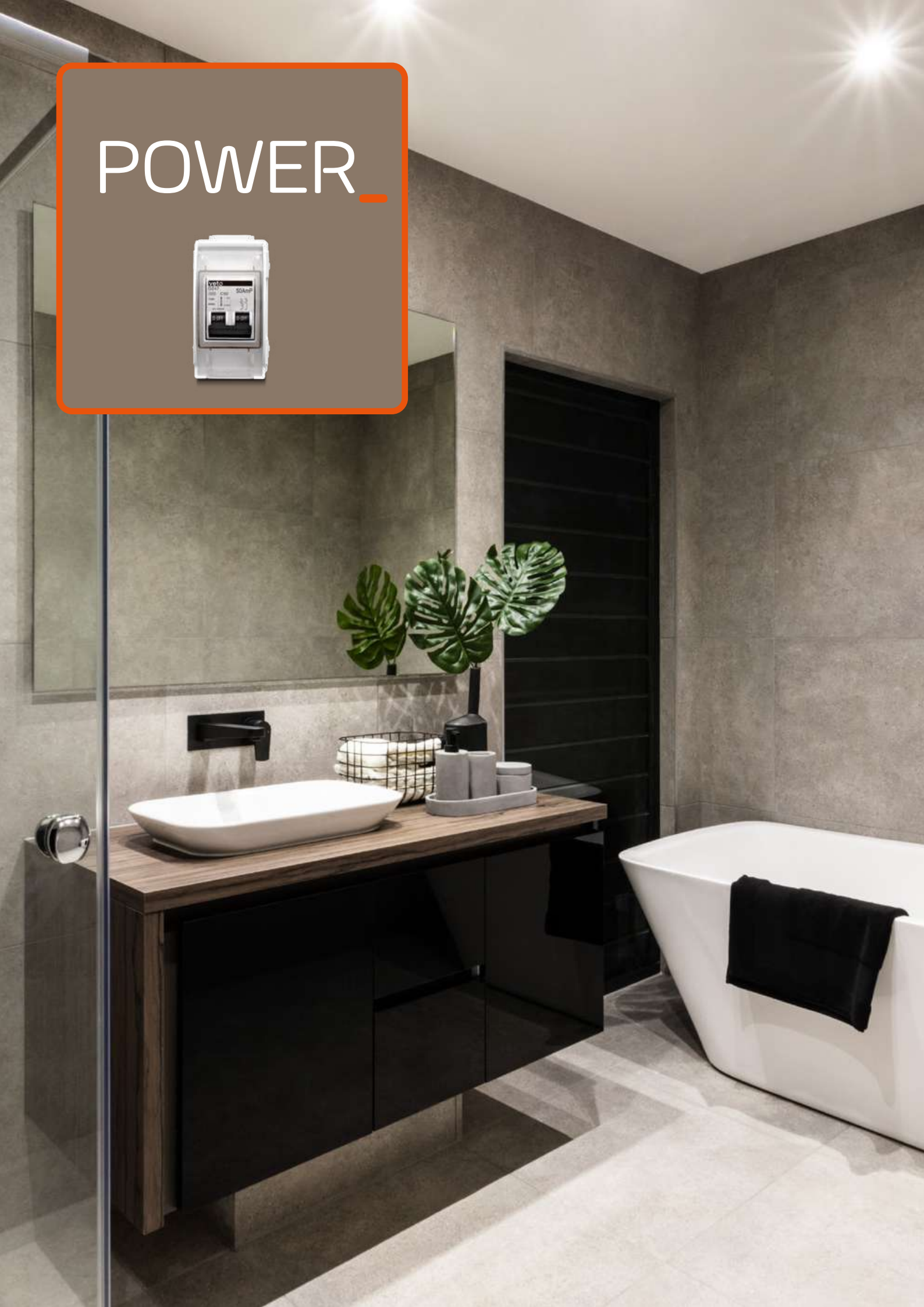

POWER



CARACTERISTICAS

Sellado y resistente al agua y humedad IP 6 5
Protección Termomagnética contra corto circuitos
y sobrecargas
25, 32, 40, 50, 63 Amp
Termopolímero de última generación
10 Años de garantía Internacional.

CERTIFICACIONES

Certificación que cumple con la
Norma IEC60898-1

DIAGRAMA DE INSTALACION

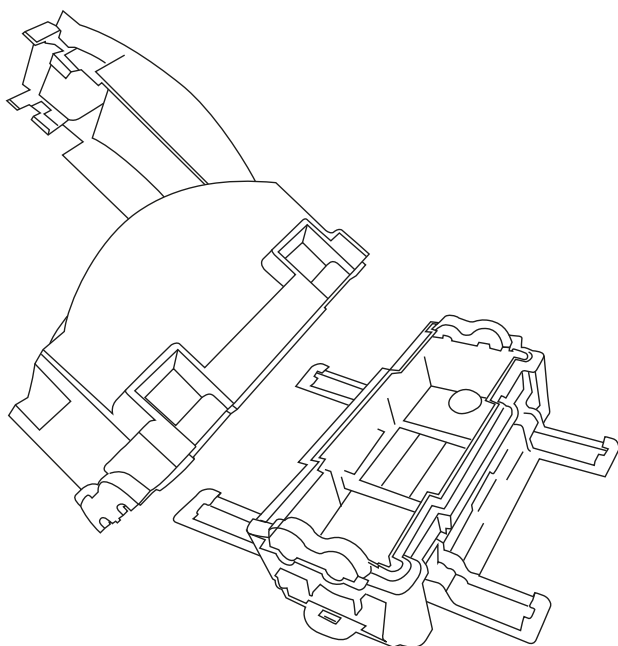

POWER



110 V	220 V	
POW25018	POW25001	25 AMP
POW32030	POW32009	32 AMP
POW40004	POW40011	40 AMP
POW50003	POW50010	50 AMP
POW63003	POW63010	63 AMP

INTERRUPTOR TERMOMAGNÉTICO



POW32016	32 AMP
POW40028	40 AMP
POW50027	50 AMP
POW63027	63 AMP

INTERRUPTOR TERMOMAGNÉTICO

veto

VETO

V
VETO
ITALY

V
VETO

veto®







VETO GLOBAL SOURCING LTD
402 Jardine House, 1 Connaught Place,
Central, Hong Kong.

CONTACTOS

info@vetoelectric.com

 Veto Electric

 veto_electric

 Veto Electric

www.vetoelectric.com

CONOCE MÁS



Página web



Tutoriales



Catálogo